

UnB

Departamento de
Ciência da Computação

Autômatos Divertidos - Nuětchama ãäwerü'ätchi

Autores:

Professor: Edison Ishikawa

Alunos:

Adimir Carlos Tauana,
Aldevalson Pinheiro Pereira,
Daltro Oliveira Vinuto
Eversen Binder Flores Tomé.

Pupunha



ĩtü

Jararaca



Ã'tape

Arara



Tehara

Tatu



ĩ'cü

Jacaré



Yoca

Curupira



Curupira

Casa







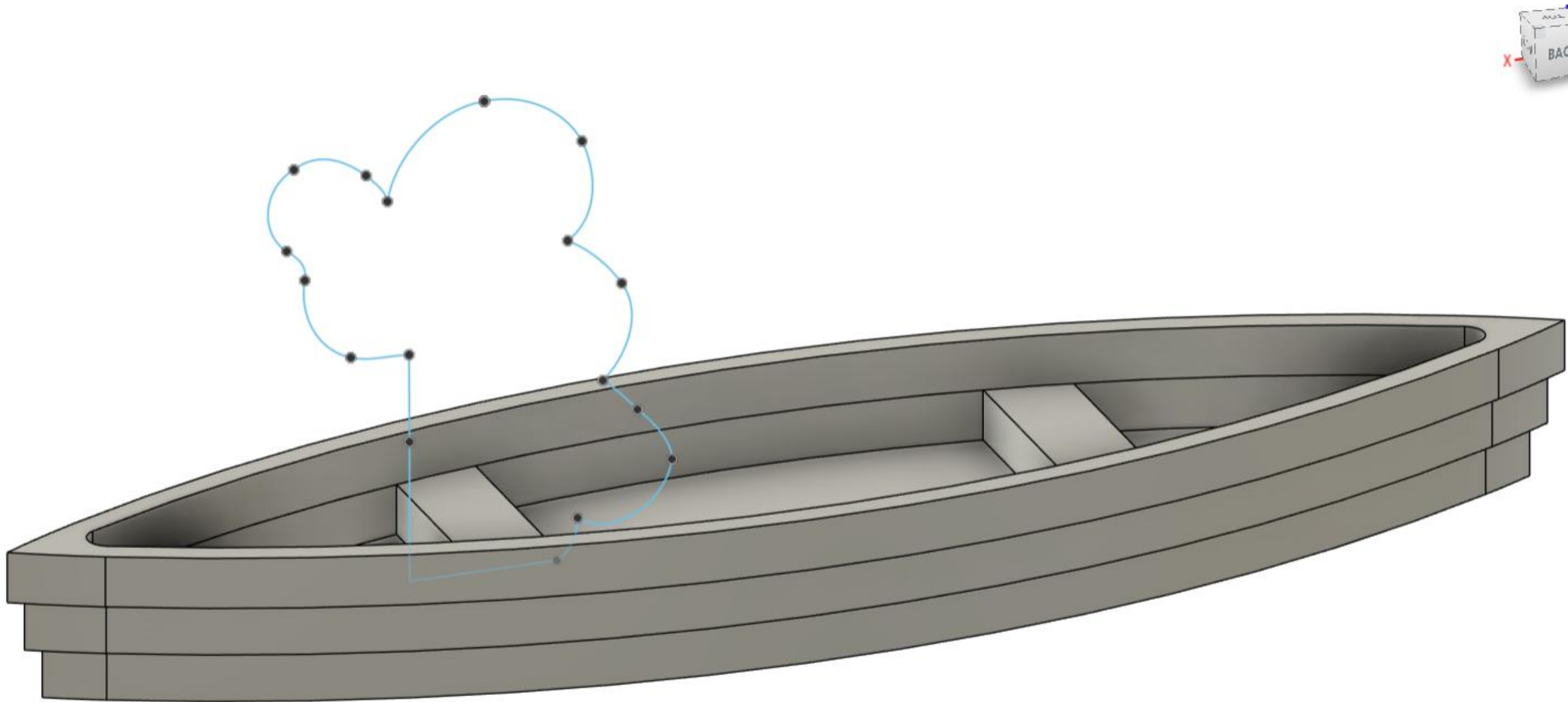

Ĩ'pata

Tartaruga

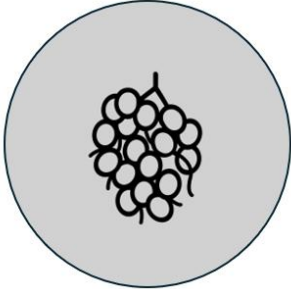
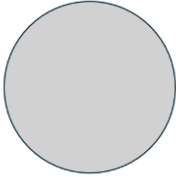
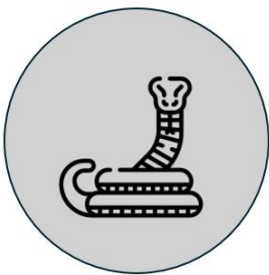
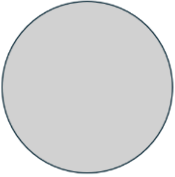
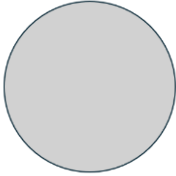
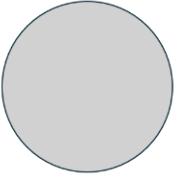

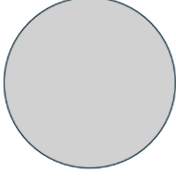
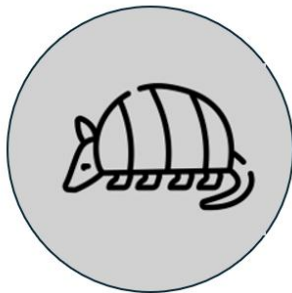
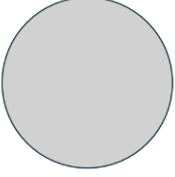
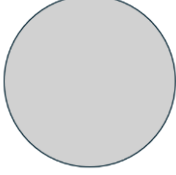
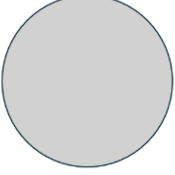
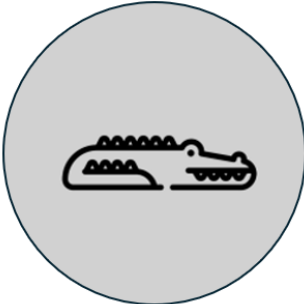
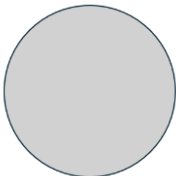
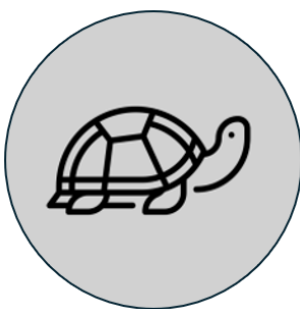
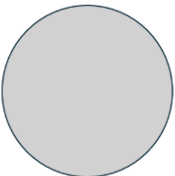
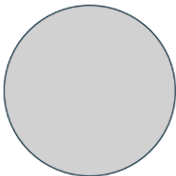
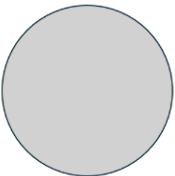
To'ri

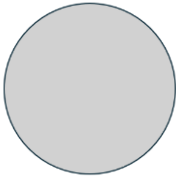

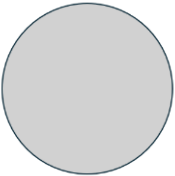
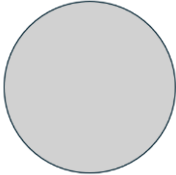
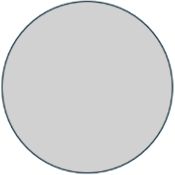
Estado Atual	Evento	Próx. Estado	Estado Atual	Evento	Próx. Estado
					
					
					
					
					
					
					
					

Exercícios:

Caça ao tesouro:

Referência: Barichello, Leonardo. *Computação Desplugada*. Unicamp, Campinas, 2021. Disponível em: www.desplugada.ime.unicamp.br. Acesso em: *data de hoje*.